



Accu-P[®] Thin-Film Capacitors Act as Band Reject Filters

Technology Leadership Across the Board

A B S T R A C T :

AVX Accu-P[®] capacitors exhibit excellent resonance stability which makes them ideal for Band Reject Filters, whereas Ceramic capacitors are unsuitable due to their wide SRF scatter.

Avital Yaish
AVX Corporation

Accu-P® Thin-Film Capacitors Act as Band Reject Filters

Avital Yaish
AVX Corporation

Definition of Band Reject Filters (BRF)

An Outline of Band Reject Filters

Band reject, or notch, filters are used to reject a narrow frequency band and pass a wide frequency range.

Traditionally, BRF's are custom designed for each specific frequency application.

Basic design

A BRF can be realized by a simple shunt capacitor (Figure 1) or by a more elaborate Twin T design (Figure 2)

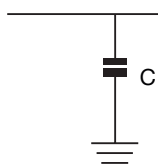

Figure 1.
Shunt Capacitor Design

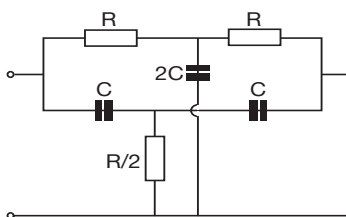

Figure 2.
Twin T Design

Major applications

Band reject filters (BRF) perform several basic functions in RF circuits.

A. Additional filtering of the basic signal harmonics (2F0, 3F0, 4F0).

In this case, the BRF is located either at the PA output or next to the antenna:

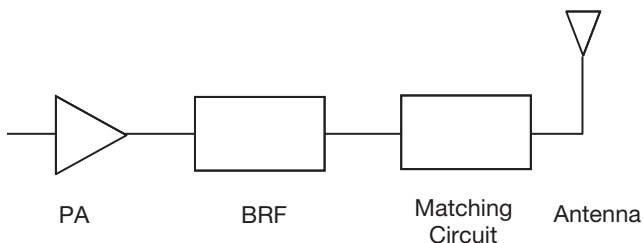

Harmonic rejection is usually performed by a LPF located after the PA, but the need often arises to suppress a spurious harmonic at a later stage of development or when the circuit is actually in production. In these cases an AVX Accu-P® Thin-Film RF capacitor is the preferred solution.

The exact capacitance value should be determined experimentally as it will be affected by the surrounding circuit.

B. Intermodulation frequencies suppression.

Transceiver characteristics may be affected by internally generated frequencies. In these cases the signal frequency and amplitude are known so that a narrow band BRF is ideally suited for the application.

C. Multi-Band Systems. In multi-band transceivers, which operate at several frequencies, BRF are used as additional decoupling elements both in the receiving and the transmitting channel. When several RF systems work simultaneously, e.g. WCDMA at 1.9 GHz and short range accessories at 2.4 GHz or 5.2 GHz, parasitic signals may form in the main channel, lowering the receiver sensitivity.

BRF realization using Accu-P® Capacitors

AVX's Accu-P® Thin-Film RF capacitors are a simple BRF that is both cost effective and miniature. Until recently, most high frequency/microwave capacitors were based on fired-ceramic (porcelain) technology. Layers of ceramic dielectric material and metal alloy electrode paste are interleaved and then sintered in a high temperature oven. This technology exhibits component variability in dielectric properties (losses, dielectric constant and insulation resistance), variability in electrode conductivity and variability in physical size.

The Thin-Film Capacitors developed by AVX virtually eliminate these variances. Thin-Film technology is commonly used for producing semiconductor devices. In the last two decades, this technology has developed tremendously, both in performance and in process control. Today line definitions of below 1 μm and layer thickness control of 100 \AA (10-2 μm) are possible. Applying this technology to the manufacture of capacitors has enabled the development of components where both electrical and physical properties can be tightly controlled.

Accu-P® RF Capacitors are made by Thin-Film Technology (see Figure 3) and exhibit nearly ideal characteristics.

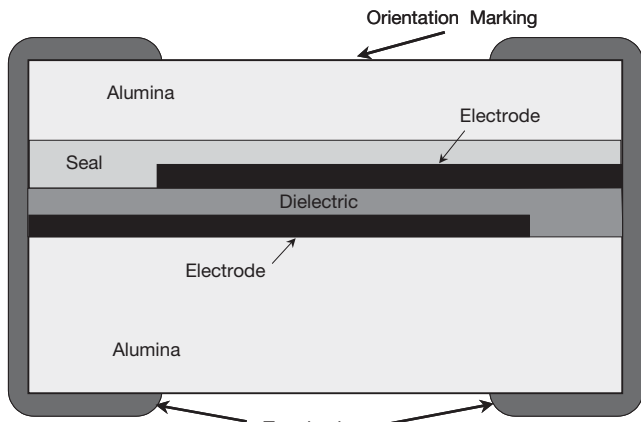

Figure 3.
Accu-P® Capacitor Structure

The main features of Accu-P® may be summarized as follows:

- High purity of electrodes for very low and repeatable ESR.
- Highly pure, low-K dielectric for high breakdown voltage, high insulation resistance and low losses at frequencies up to 40GHz.
- Very tight dimensional control for uniform and stable frequency characteristics, unit to unit, batch to batch, year after year.
- Very tight capacitance tolerances for high frequency signal applications.

Accu-P® capacitors are the ideal component for realizing the simple notch filter shown in Figure 1. For each capacitance value a very stable impedance is displayed over a wide range of frequencies, see Figure 4.

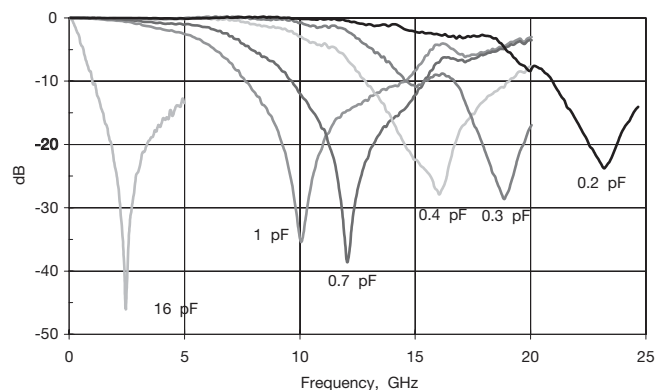

Figure 4.
S21 for Several Capacitance Values, Accu-P® 0402

The capacitance value is experimentally determined for each specific application.

Table 1 and Figure 5. show Accu-P®'s excellent resonance stability compared to ceramic capacitors which cannot be used as BRF's because of their wide SRF scatter.

BRF Design steps:

Table 1
SRF [MHz] for Accu-P® 0402, 0.2 pF
4 different production batches.

#	Batch 1	Batch 2	Batch 3	Batch 4
1	23,256	23,256	23,459	23,198
2	23,199	23,290	23,479	23,246
3	23,256	23,256	23,483	23,204
4	23,238	23,199	23,479	23,161
5	23,217	23,199	23,461	23,170
6	23,199	23,276	23,479	23,178
7	23,272	23,296	23,472	23,210
8	23,238	23,260	23,479	23,188
9	23,256	23,288	23,461	23,226
10	23,232	23,238	23,441	23,179
AVG	23,236	23,256	23,470	23,196
MAX	23,272	23,296	23,483	23,246
MIN	23,199	23,199	23,441	23,161
STD	25	35	14	26

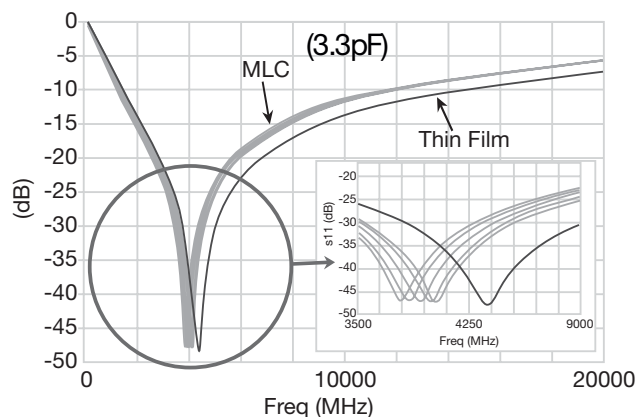
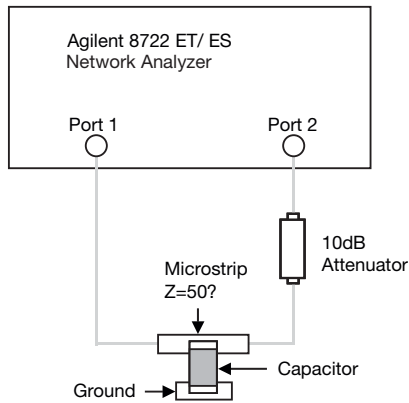

Figure 5.
Typical Thin-Film vs. Ceramic MLC SRF Distribution.

- Determine the frequency FO that needs to be rejected.
- Select an Accu-P® capacitor case size.
- Use the SRF vs. Capacitance graph (Appendix 2) for the selected case size in order to find an Accu-P® capacitance with an SRF closest to FO.
- Order samples of that Accu-P® capacitance as well as of neighboring capacitance values.
- For a wider selection range order Accu-P® Engineering Kits (Appendix 3).
- The best Accu-P® capacitance value for the particular circuit can now be experimentally determined.

Appendix 1: Measurement Technique



SRF Test Setup

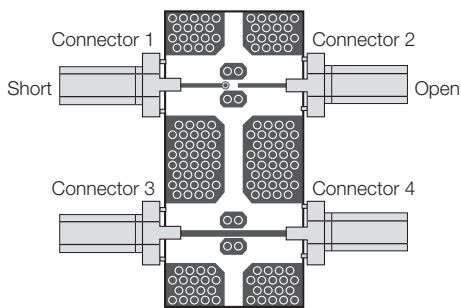

Measurement Jig

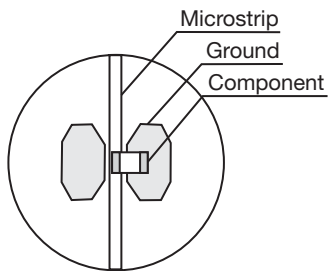

Close-up of Capacitor on Jig

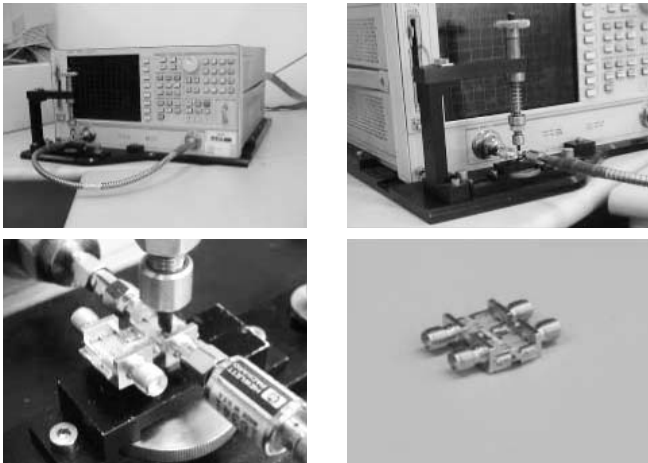

Test Setup

Appendix 2 : SRF vs. Capacitance Graphs

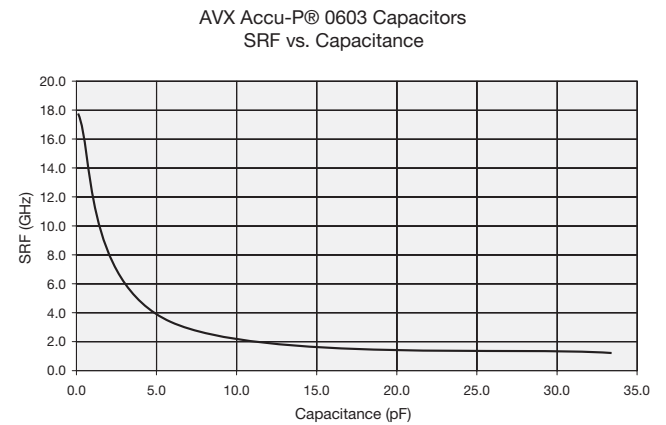
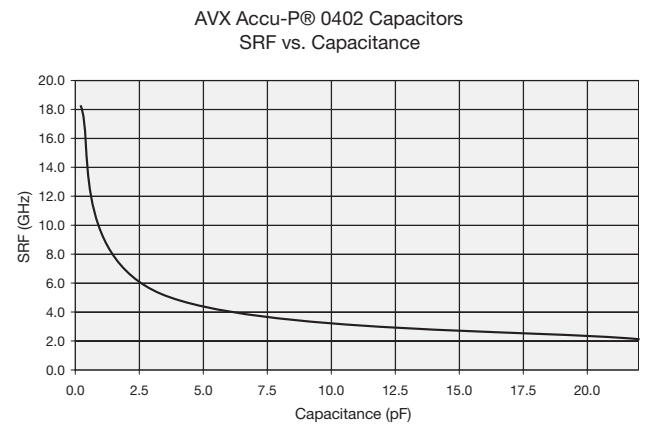
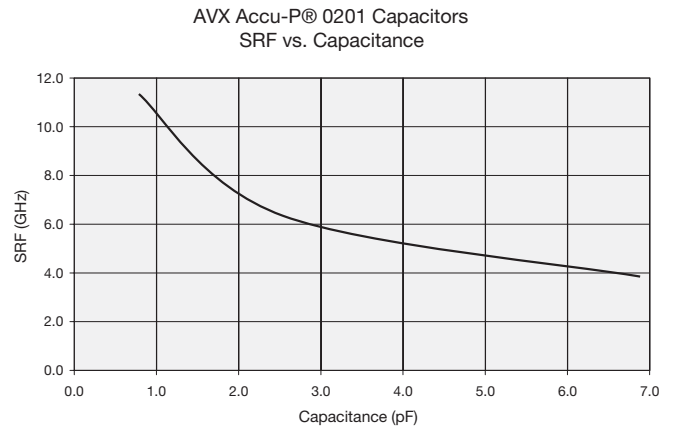

Appendix 3: Engineering Kits

Accu-P®
Designer Kit Type 1700
Order Number: Accu-P® 0201KIT02

Volts	Capacitors Value pF	Tolerance
25	0.1	A
	0.2	A
	0.3	A
	0.4	B
	0.5	B
	0.6	B
	0.7	B
	0.8	B
	0.9	B
	1.0	B
	1.1	B
	1.2	B
	1.3	B
	1.5	B
	1.8	B
2.0	B	
2.2	B	
2.4	B	
2.7	B	
16	3.0	B
	3.3	B
	3.6	B
	3.9	B
10	4.7	B
	5.6	B
	6.8	B
	7.5	B
	8.2	B
	10.0	G
	12.0	G

600 Capacitors, 20 each of 30 values
Tolerance A = ± 0.05pF
 B = ± 0.1pF
 G = ± 2%

Accu-P®
Designer Kit Type 1800
Order Number: Accu-P® 0201KIT03

Volts	Capacitors Value pF	Tolerance
25	1.0	A
	1.1	A
	1.2	A
	1.3	A
	1.4	A
	1.5	A
	1.6	A
	1.7	A
	1.8	A
	1.9	A
	2.0	A
	2.1	B
	2.2	B
	2.3	B
	2.4	B
2.5	B	
2.6	B	
2.7	B	
16	2.8	B
	2.9	B
	3.0	B
	3.1	B
	3.3	B
	3.4	B
	3.6	B
3.9	B	
10	4.1	B
	4.3	B
	4.5	B
	4.7	B
		B

600 Capacitors, 20 each of 30 values
Tolerance A = ± 0.05pF
 B = ± 0.1pF

Accu-P®
Designer Kit Type 1300
Order Number: Accu-P® 0402KIT01

Volts	Capacitors Value pF	Tolerance
25	0.1	A
	0.2	A
	0.3	A
	0.4	B
	0.5	B
	0.6	B
	0.7	B
	0.8	B
	0.9	B
	1.0	B
	1.1	B
	1.2	B
	1.5	B
	1.8	B
	2.0	B
	2.2	B
	2.4	B
	2.7	B
16	3.0	B
	3.3	B
	3.9	B
	4.7	B
10	5.6	B
	6.8	B
	8.2	B
	10.0	G
	12.0	G
10	15.0	G
	18.0	G
	22.0	G
		G
		G

600 Capacitors, 20 each of 30 values
Tolerance A = ± 0.05pF
 B = ± 0.1pF
 G = ± 2%

Accu-P®
Designer Kit Type 1400
Order Number: Accu-P® 0402KIT02

Volts	Capacitors Value pF	Tolerance
25	1.0	A
	1.1	A
	1.2	A
	1.3	A
	1.4	A
	1.5	A
	1.6	A
	1.7	A
	1.8	A
	1.9	A
	2.0	A
	2.1	B
	2.2	B
	2.3	B
	2.4	B
	2.5	B
	2.6	B
	2.7	B
	2.8	B
	2.9	B
	3.0	B
	3.1	B
	3.3	B
	3.4	B
3.6	B	
3.9	B	
4.1	B	
4.3	B	
4.5	B	
4.7	B	

600 Capacitors, 20 each of 30 values
Tolerance A = ± 0.05pF
 B = ± 0.1pF

Accu-P®
Designer Kit Type 900
Order Number: Accu-P® 0603KIT01

Volts	Capacitors Value pF	Tolerance
50	0.1	A
	0.2	A
	0.3	A
	0.4	B
	0.5	B
	0.6	B
	0.7	B
	0.8	B
	0.9	B
	1.0	B
	1.1	B
	1.2	B
	1.5	B
	1.8	B
	2.0	B
	2.2	B
	2.4	B
	2.7	B
3.0	B	
3.3	B	
3.9	B	
4.7	B	
5.6	B	
6.8	B	
8.2	B	
10.0	G	
12.0	G	
25	15.0	G
	18.0	G
	22.0	G

600 Capacitors, 20 each of 30 values
Tolerance A = ± 0.05pF
 B = ± 0.1pF
 G = ± 2%

Accu-P®
Designer Kit Type 800
Order Number: Accu-P® 0805KIT02

Volts	Capacitors Value pF	Tolerance
100	0.1	A
	0.2	A
	0.3	A
	0.4	A
	0.5	B
	0.7	B
	0.8	B
	0.9	B
	1.0	B
	1.2	B
	1.5	B
	1.8	B
	2.0	B
	2.2	B
	2.7	B
	3.3	B
	3.9	B
	4.7	B
5.6	B	
6.8	B	
8.2	B	
10.0	G	
50	12.0	G
	15.0	G
	18.0	G
	22.0	G
25	27.0	J
	33.0	J
	39.0	J
	47.0	J
		J

300 Capacitors, 10 each of 30 values
Tolerance A = ± 0.05pF G = ± 2%
 B = ± 0.1pF J = ± 5%

Appendix 3: Engineering Kits (Cont.)

Accu-P®
 Designer Kit Type 700
 Order Number: Accu-P® 1210KIT02

Volts	Capacitors Value pF	Tolerance
100	1.0	B
	1.5	B
	1.8	B
	2.2	B
	2.7	B
	3.3	B
	4.7	B
	5.6	B
	6.8	B
	10.0	G
	12.0	G
	18.0	G
	22.0	G
27.0	G	
33.0	G	

150 Capacitors, 10 each of 15 values
Tolerance B = ± 0.1pF
 G = ± 2%

Accu-P®
 Designer Kit Type 2100
 Order Number: Accu-P® 0402KIT03

Volts	Capacitors Value pF	Tolerance
25	0.05	P
	0.10	P
	0.15	P
	0.20	P
	0.25	P
	0.30	P
	0.35	P
	0.40	P
	0.45	P
	0.50	P
	0.55	P
	0.60	P
	0.65	P
	0.70	P
	0.75	P

300 Capacitors, 20 each of 15 values
Tolerance P = ± 0.02pF

Accu-P®
 Designer Kit Type 2200
 Order Number: Accu-P® 0603KIT02

Volts	Capacitors Value pF	Tolerance
50	0.05	P
	0.10	P
	0.15	P
	0.20	P
	0.25	P
	0.30	P
	0.35	P
	0.40	P
	0.45	P
	0.50	P
	0.55	P
	0.60	P
	0.65	P
	0.70	P
	0.75	P

300 Capacitors, 20 each of 15 values
Tolerance P = ± 0.02pF

Accu-P®
 Designer Kit Type 2000
 Order Number: Accu-P® 0201KIT04

Volts	Capacitors Value pF	Tolerance
25	0.05	P
	0.10	P
	0.15	P
	0.20	P
	0.25	P
	0.30	P
	0.35	P
	0.40	P
	0.45	P
	0.50	P
	0.55	P
	0.60	P
	0.65	P
	0.70	P
	0.75	P

300 Capacitors, 20 each of 15 values
Tolerance P = ± 0.02pF

AMERICAS

**AVX Myrtle Beach, SC
Corporate Offices**
Tel: 843-448-9411
FAX: 843-448-1943

AVX Northwest, WA
Tel: 360-699-8746
FAX: 360-699-8751

AVX North Central, IN
Tel: 317-848-7153
FAX: 317-844-9314

AVX Midwest, MN
Tel: 952-974-9155
FAX: 952-974-9179

AVX Mid/Pacific, CA
Tel: 510-661-4100
FAX: 510-661-4101

AVX Southwest, AZ
Tel: 602-678-0384
FAX: 602-678-0385

AVX South Central, TX
Tel: 972-669-1223
FAX: 972-669-2090

AVX Southeast, GA
Tel: 404-608-8151
FAX: 770-972-0766

AVX Canada

Tel: 905-238-3151
FAX: 905-238-0319

AVX South America
Tel: ++55-11-2193-7200
FAX: ++55-11-2193-7210

EUROPE

**AVX Limited, England
European Headquarters**
Tel: ++44 (0) 1252-770000
FAX: ++44 (0) 1252-770001

AVX/ELCO, England
Tel: ++44 (0) 1638-675000
FAX: ++44 (0) 1638-675002

AVX S.A., France
Tel: ++33 (1) 69-18-46-00
FAX: ++33 (1) 69-28-73-87

AVX GmbH, Germany
Tel: ++49 (0) 8131-9004-0
FAX: ++49 (0) 8131-9004-44

AVX srl, Italy

Tel: ++390 (0)2 614-571
FAX: ++390 (0)2 614-2576

AVX Czech Republic
Tel: ++420 57 57 57 521
FAX: ++420 57 57 57 109

ASIA-PACIFIC

**AVX/Kyocera, Singapore
Asia-Pacific Headquarters**
Tel: (65) 6286-7555
FAX: (65) 6488-9880

AVX/Kyocera, Hong Kong
Tel: (852) 2-363-3303
FAX: (852) 2-765-8185

AVX/Kyocera, Korea
Tel: (82) 2-785-6504
FAX: (82) 2-784-5411

AVX/Kyocera, Taiwan
Tel: (886) 2-2698-8778
FAX: (886) 2-2698-8777

AVX/Kyocera, Malaysia
Tel: (60) 4-228-1190
FAX: (60) 4-228-1196

Elco, Japan

Tel: 045-943-2906/7
FAX: 045-943-2910

Kyocera, Japan - AVX
Tel: (81) 75-604-3426
FAX: (81) 75-604-3425

Kyocera, Japan - KDP
Tel: (81) 75-604-3424
FAX: (81) 75-604-3425

AVX/Kyocera, Shanghai, China

Tel: 86-21 6341 0300
FAX: 86-21 6341 0330

AVX/Kyocera, Beijing, China
Tel: 86-10 8458 3385
Fax: 86-10 8458 3382

ASIA-KED

KED, Hong Kong
Tel: (852) 2305 1080
FAX: (852) 2305 1405

KED, Shanghai
Tel: (86) 21 6859 9898
FAX: (86) 21 5887 2542

KED, Beijing
Tel: (86) 10 5869 4655
FAX: (86) 10 5869 4677

KED, South Korea
Tel: (82) 2 783 3288
FAX: (82) 2 783 3207

KED, Taiwan
Tel: (886) 2 2950 0268
FAX: (886) 2 2950 0520

KED, Singapore
Tel: (65) 6255 3122
FAX: (65) 6255 5092

Contact:

